

Data Sheet



Article number: 209925D30M10

Description: E+G Threaded end-caps - GN 992.5-D30-M10

Measures

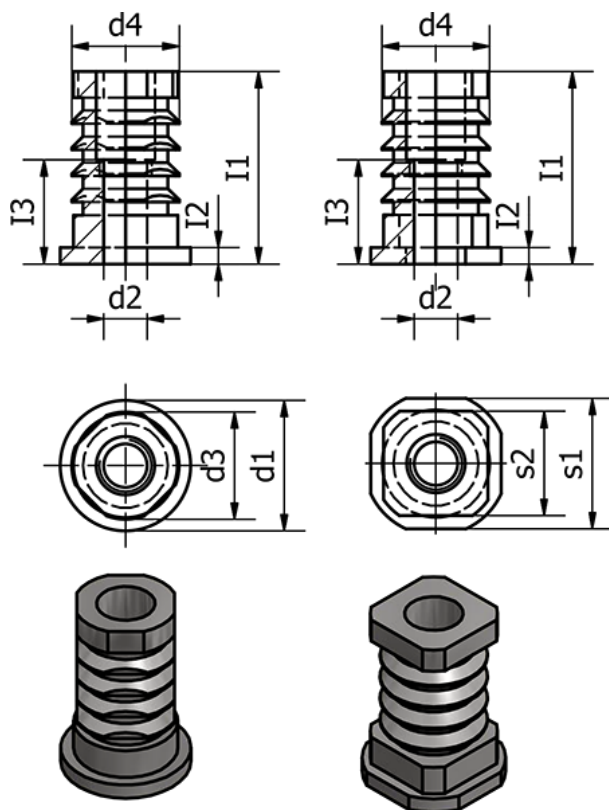

d1 = 30

d2 = M10

d3 = 26

d4 = 26.5

I1 = 29.5

I2 = 2.5

I3 = 18

s1 =

s2 =

Weight (g) = 90